

# CMPA2060035F

## 35 W, 2.0 - 6.0 GHz, GaN MMIC Power Amplifier

Cree's CMPA2060035F is a gallium nitride (GaN) High Electron Mobility Transistor (HEMT) based monolithic microwave integrated circuit (MMIC). GaN has superior properties compared to silicon or gallium arsenide, including higher breakdown voltage, higher saturated electron drift velocity and higher thermal conductivity. GaN HEMTs also offer greater power density and wider bandwidths compared to Si and GaAs transistors. This MMIC contains a two-stage reactively matched amplifier enabling very wide bandwidths to be achieved in a small footprint screw-down package featuring a Copper-Tungsten heat-sink.

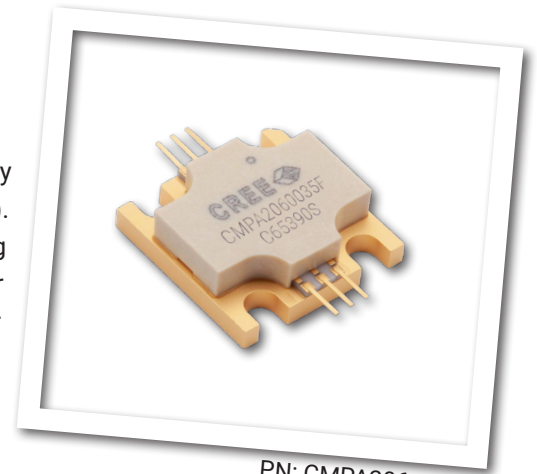

PN: CMPA2060035F  
Package Type: 440219

### Typical Performance Over 2.0-6.0 GHz ( $T_c = 25^\circ\text{C}$ )

Parameter	2.0 GHz	4.0 GHz	6.0 GHz	Units
Small Signal Gain	25.6	28.5	26.8	dB
Output Power <sup>1</sup>	27.4	54	37	W
Power Gain <sup>1</sup>	17.4	20.3	18.7	dB
Power Added Efficiency <sup>1</sup>	33	47.2	34.2	%

Note<sup>1</sup>:  $V_{DD} = 32\text{ V}$ ,  $I_{DQ} = 1.2\text{ A}$ ,  $P_{IN} = 27\text{ dBm}$ . All data tested CW

### Features

- 28 dB Small Signal Gain
- 35 W Typical  $P_{SAT}$
- Operation up to 32 V
- High Breakdown Voltage
- High Temperature Operation

### Applications

- Ultra Broadband Amplifiers
- Fiber Drivers
- Test Instrumentation
- EMC Amplifier Drivers

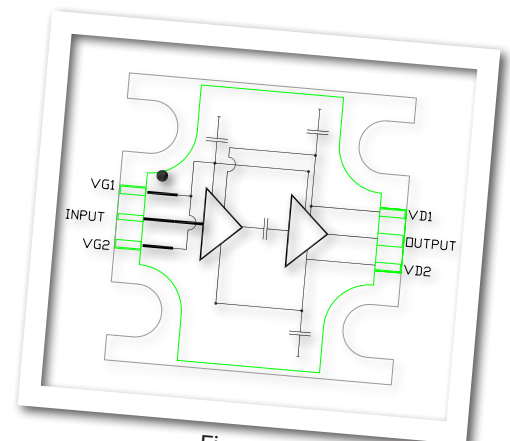

Figure 1.

## Absolute Maximum Ratings (not simultaneous) at 25°C

Parameter	Symbol	Rating	Units	Conditions
Drain-source Voltage	$V_{DSS}$	84	VDC	
Gate-source Voltage	$V_{GS}$	-10, +2	VDC	
Storage Temperature	$T_{STG}$	-65, +150	°C	
Operating Junction Temperature	$T_J$	225	°C	
Forward Gate Current	$I_G$	16	mA	
Screw Torque	T	40	in-oz	
Thermal Resistance, Junction to Case	$R_{\theta JC}$	1.67	°C/W	85 °C, $P_{DISS} = 65$ W, CW
Case Operating Temperature	$T_C$	-40, +115	°C	

## Electrical Characteristics (Frequency = 2.0 GHz to 6.0 GHz unless otherwise stated; $T_C = 25^\circ\text{C}$ )

Characteristics	Symbol	Min.	Typ.	Max.	Units	Conditions
<b>DC Characteristics<sup>1,2</sup></b>						
Gate Threshold Voltage	$V_{(GS)TH}$	-3.6	-3.1	-2.4	V	$V_{DS} = 10$ V, $I_D = 16.8$ mA
Gate Quiescent Voltage	$V_{(GS)Q}$	-	-2.7	-	VDC	$V_{DD} = 28$ V, $I_D = 1.2$ A
Drain-Source Breakdown Voltage	$V_{BD}$	84	-	-	V	$V_{GS} = -8$ V, $I_D = 16.8$ mA
Saturated Drain Current <sup>1</sup>	$I_{DC}$	12.6	15.1	-	A	$V_{DS} = 6.0$ V, $V_{GS} = 2.0$ V
<b>RF Characteristics<sup>3,4,5</sup></b>						
Small Signal Gain	S21	-	28.8	-	dB	$V_{DD} = 32$ V, $I_{DQ} = 1.2$ A, $P_{IN} = -30$ dBm
Input Return Loss	S11	-	-10.7	-	dB	$V_{DD} = 32$ V, $I_{DQ} = 1.2$ A, $P_{IN} = -30$ dBm
Output Return Loss	S22	-	-12.5	-	dB	$V_{DD} = 32$ V, $I_{DQ} = 1.2$ A, $P_{IN} = -30$ dBm
Output Power <sub>1</sub>	$P_{OUT}$	-	27.4	-	W	$V_{DD} = 32$ V, $I_{DQ} = 1.2$ A, Freq = 2.0 GHz
Output Power <sub>2</sub>	$P_{OUT}$	-	54	-	W	$V_{DD} = 32$ V, $I_{DQ} = 1.2$ A, Freq = 4.0 GHz
Output Power <sub>3</sub>	$P_{OUT}$	-	37	-	W	$V_{DD} = 32$ V, $I_{DQ} = 1.2$ A, Freq = 6.0 GHz
Power Added Efficiency <sub>1</sub>	PAE	-	33.0	-	%	$V_{DD} = 32$ V, $I_{DQ} = 1.2$ A, Freq = 2.0 GHz
Power Added Efficiency <sub>2</sub>	PAE	-	47.2	-	%	$V_{DD} = 32$ V, $I_{DQ} = 1.2$ A, Freq = 4.0 GHz
Power Added Efficiency <sub>3</sub>	PAE	-	34.2	-	%	$V_{DD} = 32$ V, $I_{DQ} = 1.2$ A, Freq = 6.0 GHz
Power Gain <sub>1</sub>	$G_p$	-	17.4	-	dB	$V_{DD} = 32$ V, $I_{DQ} = 1.2$ A, Freq = 2.0 GHz
Power Gain <sub>2</sub>	$G_p$	-	20.3	-	dB	$V_{DD} = 32$ V, $I_{DQ} = 1.2$ A, Freq = 4.0 GHz
Power Gain <sub>3</sub>	$G_p$	-	18.7	-	dB	$V_{DD} = 32$ V, $I_{DQ} = 1.2$ A, Freq = 6.0 GHz
Output Mismatch Stress	VSWR	-	-	5 : 1	$\Psi$	No damage at all phase angles, $V_{DD} = 32$ V, $I_{DQ} = 1.2$ A, $P_{IN} = 27$ dBm

### Notes:

<sup>1</sup> Measured on-wafer prior to packaging

<sup>2</sup> Scaled from PCM data

<sup>3</sup> Measured in CMPA2060035F-AMP

<sup>4</sup> Measured at  $P_{IN} = 27$  dBm

<sup>5</sup> Tested CW

## Typical Performance

### CMPA2060035F S-Parameters

$V_{DD} = 32\text{ V}$ ,  $I_{DQ} = 1.2\text{ A}$

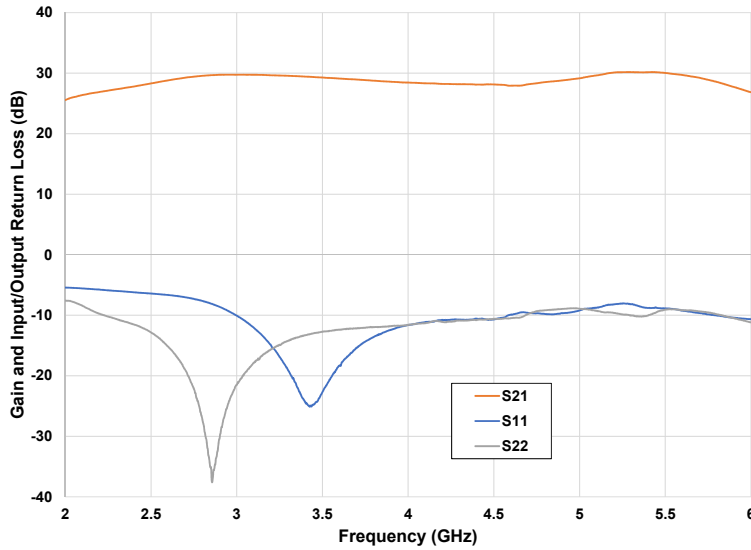

### CMPA2060035F Output Power, Gain and PAE vs. Frequency

$V_{DD} = 32\text{ V}$ ,  $I_{DQ} = 1.2\text{ A}$ ,  $P_{IN} = 27\text{ dBm}$ , CW

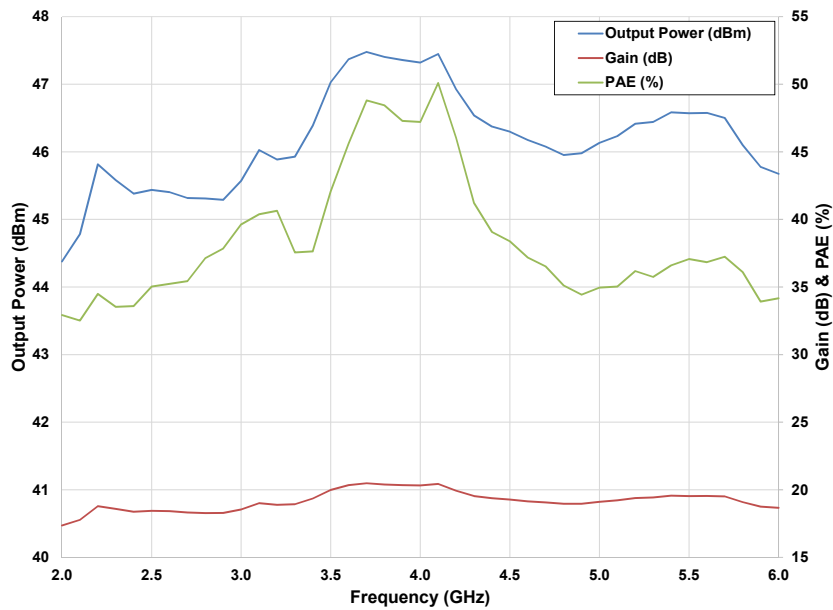

## CMPA2060035F CW Power Dissipation De-rating Curve

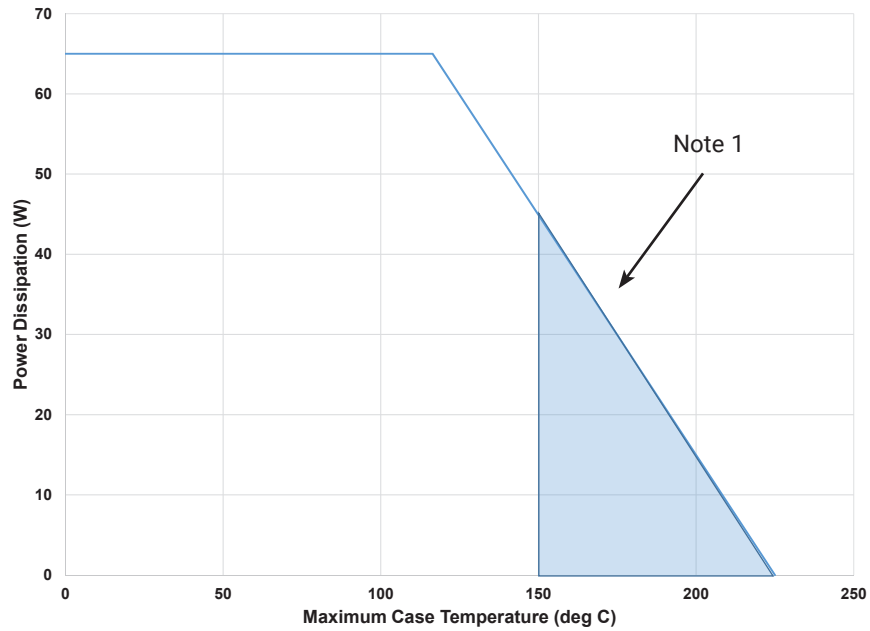

Note 1. Area exceeds Maximum Case Operating Temperature (See Page 2).

## Electrostatic Discharge (ESD) Classifications

Parameter	Symbol	Class	Test Methodology
Human Body Model	HBM	1A (> 250 V)	JEDEC JESD22 A114-D
Charge Device Model	CDM	II (200 < 500 V)	JEDEC JESD22 C101-C

## CMPA2060035F-AMP Demonstration Amplifier Circuit Schematic

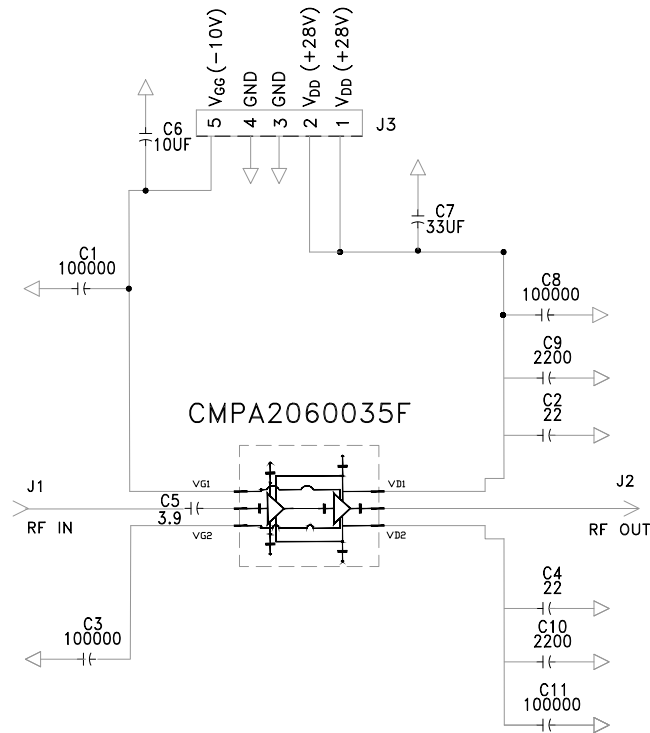

## CMPA2060035F-AMP Demonstration Amplifier Circuit Outline

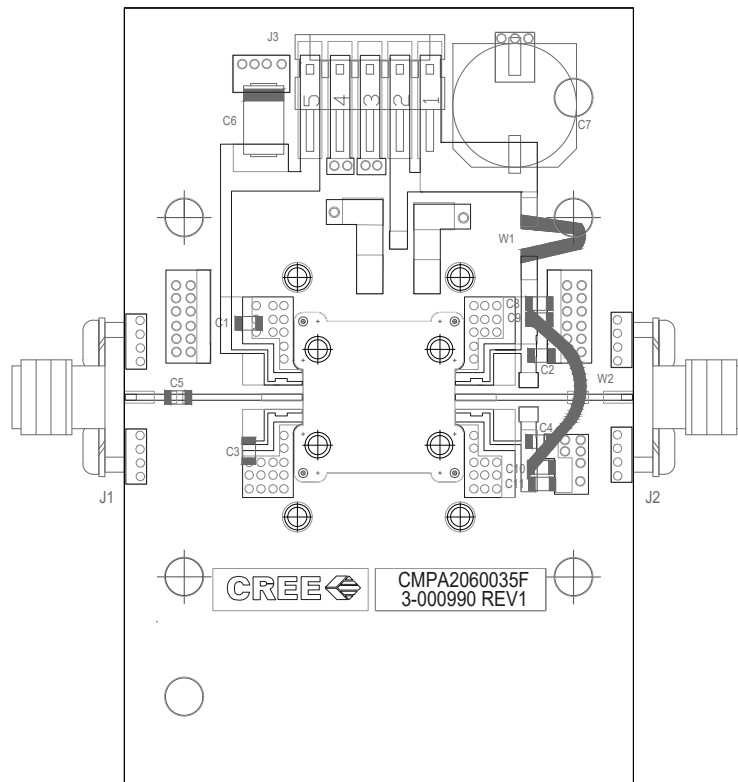

## CMPA2060035F-AMP Demonstration Amplifier Circuit Bill of Materials

Designator	Description	Qty
	PCB	1
C5	CAP, 3.9 PF, 250V, 0805, ATC600F	1
C1, C3, C8, C11	CAP, 100,000 PF, 50V, 0805, 10%	4
C6	CAP, 10 UF, 20%, G CASE	1
C7	CAP, 33 UF, 20%, G CASE	2
C9, C10	CAP, 2200 PF, 100V, 0805, 10%	2
C2, C4	CAP, 22 PF, 50V, 10%	2
J1,J2	CONN, SMA, FLANGE, 4-HOLE	2
J3	DC CONN, HEADER RT>PLZ .1CEN LK 5POS	1
	2-56 SOC HD SCREW 1/4 SS	4
	#2 FLATWASHER	4
Q1	CMPA2060035F	1

### Product Dimensions CMPA2060035F (Package Type – 440219)

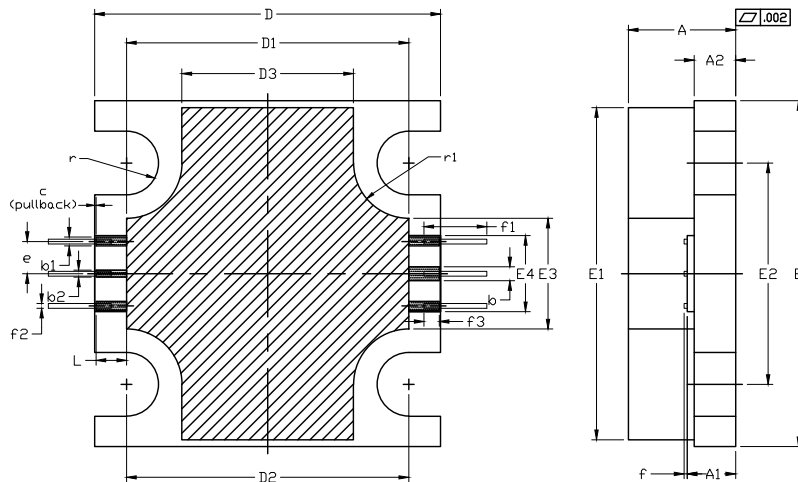

#### NOTES:

- DIMENSIONING AND TOLERANCING PER ANSI Y14.5M, 1982.
- CONTROLLING DIMENSION: INCH.
- ADHESIVE FROM LID MAY EXTEND A MAXIMUM OF 0.020" BEYOND EDGE OF LID.
- LID MAY BE MISALIGNED TO THE BODY OF THE PACKAGE BY A MAXIMUM OF 0.008" IN ANY DIRECTION.
- ALL PLATED SURFACES ARE NI/AU

DIM	INCHES		MILLIMETERS		NOTE
	MIN	MAX	MIN	MAX	
A	0.148	0.162	3.76	4.12	—
A1	0.066	0.076	1.67	1.93	—
A2	0.056	0.064	1.42	1.63	—
b	0.022	0.56	—	—	—
b1	0.013	0.33	—	—	x4
b2	0.010	0.25	—	—	—
c	0.002	0.05	—	—	x2
D	0.495	0.505	12.57	12.83	—
D1	0.403	0.413	10.23	10.49	—
D2	0.408	10.36	—	—	—
D3	0.243	0.253	6.17	6.43	—
E	0.495	0.505	12.57	12.83	—
E1	0.475	0.485	12.06	12.32	—
E2	0.320	8.13	—	—	—
E3	0.155	0.165	3.93	4.19	—
E4	0.105	0.115	2.66	2.92	—
e	0.046	1.17	—	—	x4
f	0.005	0.127	—	—	x6
f1	0.100	—	2.54	—	x6
f2	0.010	.254	—	—	x6
f3	0.022	.559	—	—	x6
L	0.044	1.12	—	—	x6
r	R0.046	R1.17	—	—	x4
r1	R0.080	R2.03	—	—	x4

## Product Ordering Information

Order Number	Description	Unit of Measure	Image
CMPA2060035F	GaN MMIC	Each	
CMPA2060035F-AMP	Test board with GaN MMIC installed	Each	



## Disclaimer

Specifications are subject to change without notice. Cree, Inc. believes the information contained within this data sheet to be accurate and reliable. However, no responsibility is assumed by Cree for its use or for any infringement of patents or other rights of third parties which may result from its use. No license is granted by implication or otherwise under any patent or patent rights of Cree. Cree makes no warranty, representation or guarantee regarding the suitability of its products for any particular purpose. "Typical" parameters are the average values expected by Cree in large quantities and are provided for information purposes only. These values can and do vary in different applications, and actual performance can vary over time. All operating parameters should be validated by customer's technical experts for each application. Cree products are not designed, intended, or authorized for use as components in applications intended for surgical implant into the body or to support or sustain life, in applications in which the failure of the Cree product could result in personal injury or death, or in applications for the planning, construction, maintenance or direct operation of a nuclear facility. CREE and the CREE logo are registered trademarks of Cree, Inc.

For more information, please contact:

Cree, Inc.  
4600 Silicon Drive  
Durham, North Carolina, USA 27703  
[www.cree.com/RF](http://www.cree.com/RF)